

MAXHUB V6

Classical Series (C5530, C6530, C7530, C8630)

Quick Start Guide



➤ Table of Contents

Safety Warnings	2
Unboxing Checklist.....	4
Installation Guide	5
Reference On Wall Mount.....	7
Installing the Wireless Module	7
Installing the OPS/Android Module.....	8
Removing OPS/Android Module	9
Product Appearance Introduction	10
Back Interface	11
Interface Function	11
Maintenance	13
Warranty.....	13

Thank you for choosing MAXHUB product.

Please read this document carefully and thoroughly before using the product. Should you have any technical questions, please contact MAXHUB technical support.

Safety Warnings

Placement

1. Should be NOT expose the product to direct sunlight or heat source.
2. Please do NOT place the product on a slope, mount on an unstable stand or an insufficiently.
3. Please do NOT put the product near devices that generate strong magnetic fields.
4. Please do NOT place any heavy objects on the product.
5. Please do NOT place the product in a humid environment for it is NOT water-proof. Keep it from water splashes.

Power

1. Please check the product's operating voltage and frequency to ensure they match the local power configuration.
2. Please unplug the device during thunderstorms.
3. Please unplug the power cable if the product will not be used for an extended period.
4. Please do NOT physically or mechanically damage the power cable.
5. Please use the MAXHUB cable and do NOT modify it.
6. Please make sure the AC is grounded.

Screen

1. Please do NOT use hard or sharp objects on the screen other than the MAXHUB stylus.
2. Please unplug the power before cleaning the product. Use a soft, dustless, and dry cloth to clean the screen.
3. Please do NOT use water or liquid detergent to clean the product.
4. Please contact the authorized reseller for thorough cleaning.
5. Please do NOT display a high-brightness image on the screen for a long period of time.

Viewing Distance

The optimal viewing distance is 3-4 times the diagonal length of the screen.

Temperature & Humidity

1. Please do NOT place the product near a heater or radioactive source.
2. If the product is moved from a cold environment to a warm one, please unplug the power cable and allow the product to gradually warm up for at least two hours to reduce moisture.
3. Operating temperature of the product is 0°C – 40°C. Operating humidity is between 0% - 90%RH.

Ventilation

Please place the product in an area with adequate ventilation, leaving at least a 10cm-space on the left, right and back, and a 20cm-space above the product.

Earphone

High volume may cause temporary or permanent hearing loss.

Please turn down the volume before you put on the earphone.

Standby

A brief press of the power button will NOT shut down the product. It will switch the product into standby mode, with only the screen turned off. To shut down the product, please press and hold the power button for approximately 3 seconds. Confirm the shutdown command in the center of the screen

Notes for Cleaning

There are numerous heat vents at the back of the device. Please do NOT spray any liquid on the device.

Rocker Switch Status

“I” means power-on state. “O” means power-off state.

Maintenance

Please contact a MAXHUB authorized reseller for maintenance or repair.

Warranty Exclusions

MAXHUB does not warranty Products that match any one or few of the following descriptions:

1. Product damage caused by disregarding the user manual's instructions.
2. Hardware damage caused by improper set up.
3. Product damage caused by unauthorized product modification or maintenance.
4. Product damage caused by using the product in an unsuitable environment.
5. Product damage caused by subjecting the product to abnormal external force.
6. Product damage caused by natural disasters or other force majeure.
7. Damage caused by freight or shipping.
8. Deliberate or accidental damage resulting from a cleaning regime not in accordance with the cleaning and maintenance instructions specified in the user manual.

Additional exclusions:

1. The Warranty does not cover consumables, including but not limited to batteries.
2. The Warranty does not cover, or is void for, products whose Product Label has been removed or defaced, as this prevents warranty and ownership identification.

- 3. The Warranty does not cover products with a damaged Warranty Sticker.
- 4. The Warranty does not cover products for which there is no certificate of purchase.
- 5. The Warranty does not cover regular maintenance, nor does it cover repairs or replacement of parts due to normal wear and tear.

Unboxing Checklist

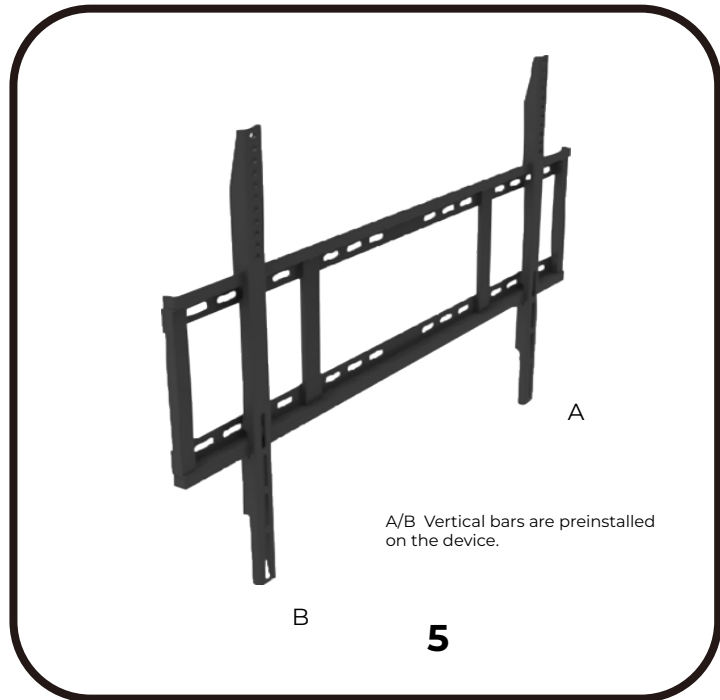
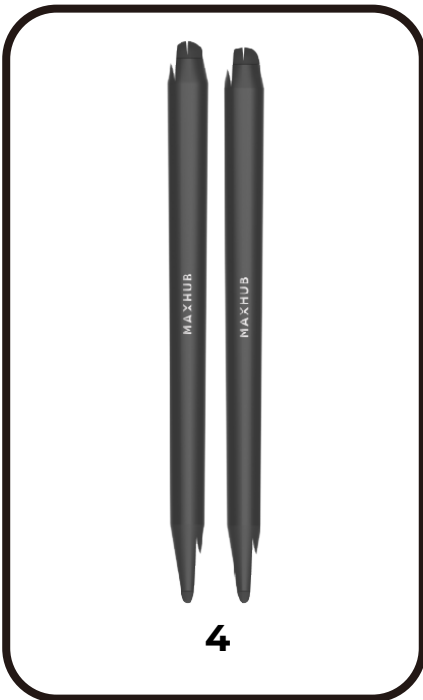
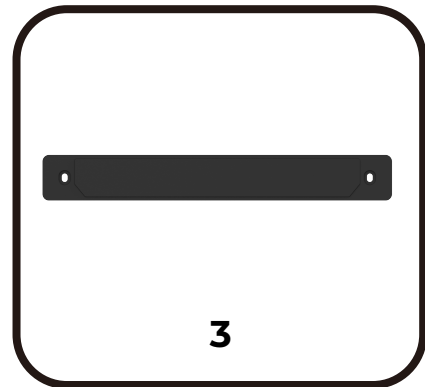
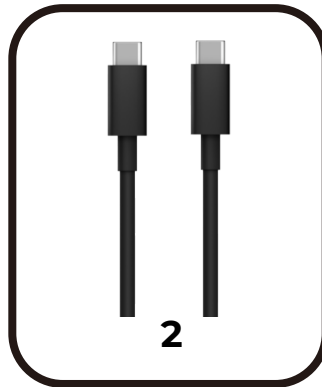

1	3m Power Cord*3 (EU*1,AU*1,UK*1)
2	1.8m USB Type-C Cable*1
3	Wi-Fi Module*1
4	Passive Stylus*2
5	VESA Wall Mounting Bracket*1

*All photos here are for reference only, Specifications are subject to the physical product.

Installation Guide

1. Remove the panel from the box and prepare for installation.

①

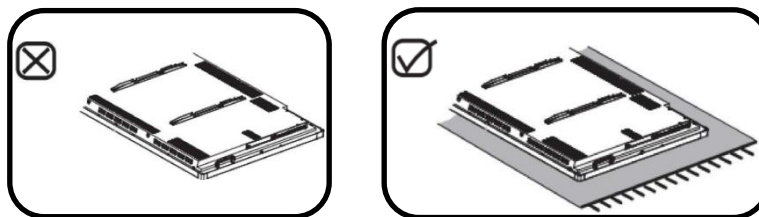

Place the panel on soft material like mat.

②



Bracket package is placed in accessory box.

2. Confirm the panel installation position.

The height and pictures are only for reference, please refer to the actual installation size on site.

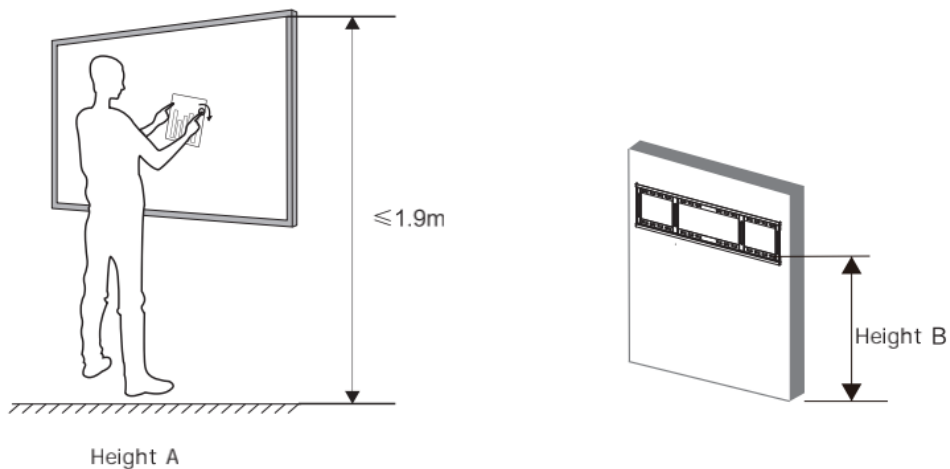

Height A: The height from the center of touch screen to the ground.

Height B: Distance from the bottom screw hole to ground.

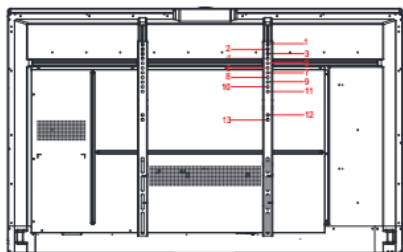

(The picture is for reference only)

Series	Size	Height B (cm)	Bracket and holes
C Series	55	120	WIB9060G- hole #13
	65	128	WIB9060G- hole #11
	75	132	WIB9060G- hole #4
V Series	86	133	WIB9060G- hole #1
	65	128	WIB9060G- hole #11
T Series	75	132	WIB9060G- hole #4
	65	127	WIB9060G- hole #4
	86	127	WIB9060G- hole #4

3. Take 8 pcs expansion rubber plug B and screw them into the wall. It is recommended to use a 10mm impact drill bit.

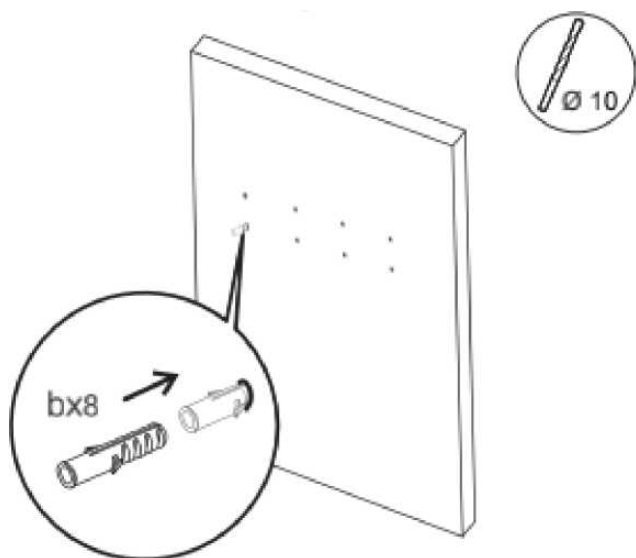

4. Fix the wall bracket onto the 8pcs expansion plug B, using a combination of 8pcs screw C and gasket D.

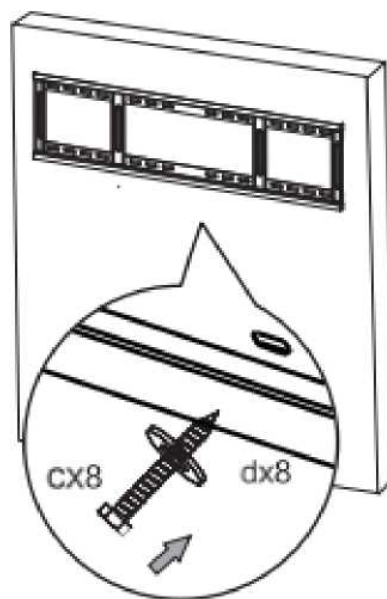

5. Reverse-tighten the safety screw to make the top of the screw reach the second screw hole.

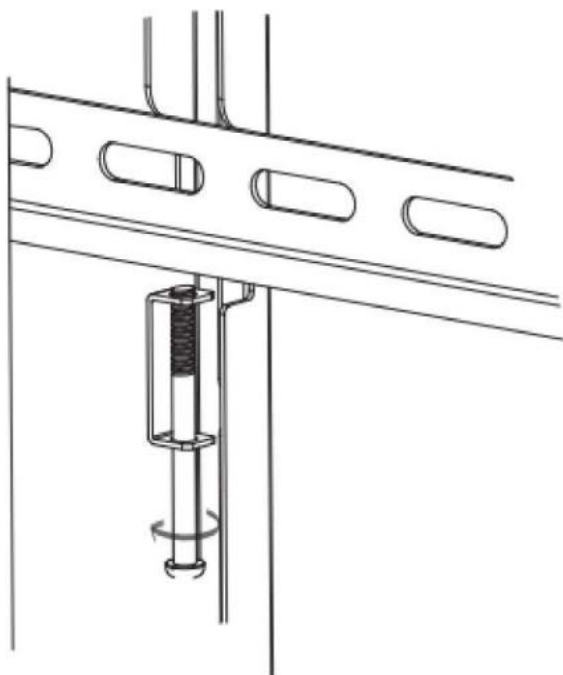

6. Hang the panel vertically on the bracket and finish installation.

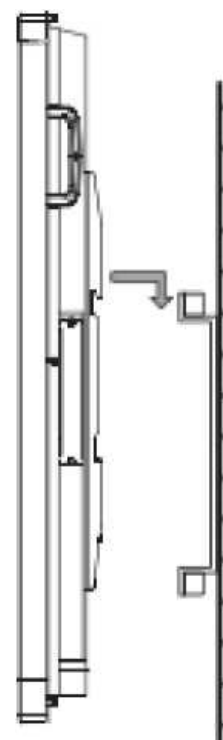

Note: This step is especially important for installation on the mobile stand. Tightening the safety screw will make the device more stable.

Note: Please keep the panel in the center of the bracket.

Reference for Wall Mounting

The physical dimensions listed below should be taken into consideration for wall mounting. For ease of operation, maintain a proper distance between the wall and rear of the product panel.

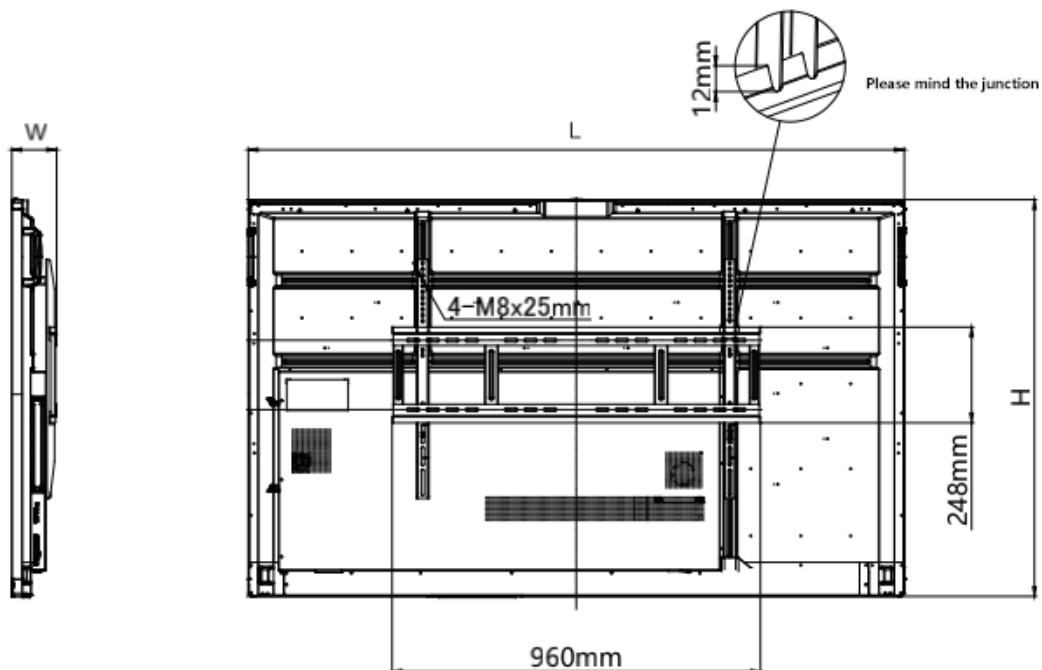

Series	Classic			
Dimension	55"	65"	75"	86"
L	1263mm	1488mm	1709mm	1957mm
H	776mm	903mm	1026mm	1160mm
W	118mm	118mm	117mm	130mm

NOTE: The table and diagram are for reference only.

Installing the Wireless Module

Please make sure that the following items are ready before setting up the wireless module.

1×Interactive Flat Panel

1×Wireless Module SI06

2×Screws (CM3×6mm, Black)

Step 1: Remove the Mylar on the bottom of the interactive flat panel.

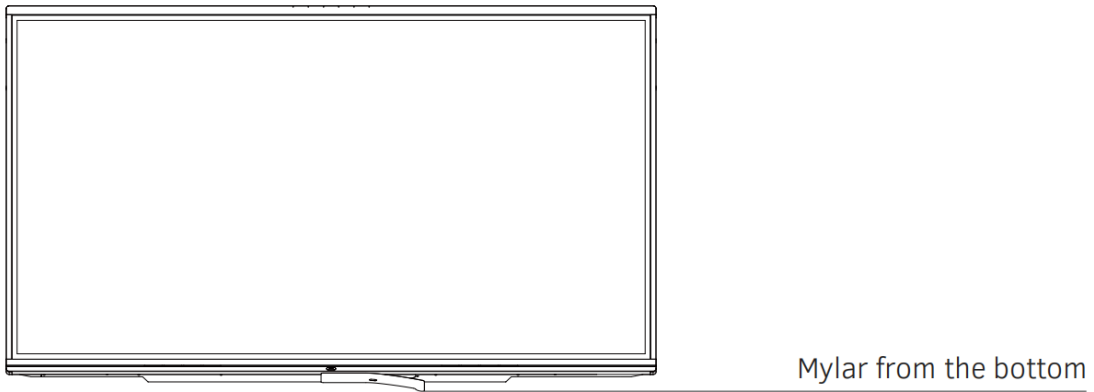

Step 2: Insert the wireless module SI06 into the wireless module slot and screw securely into place.

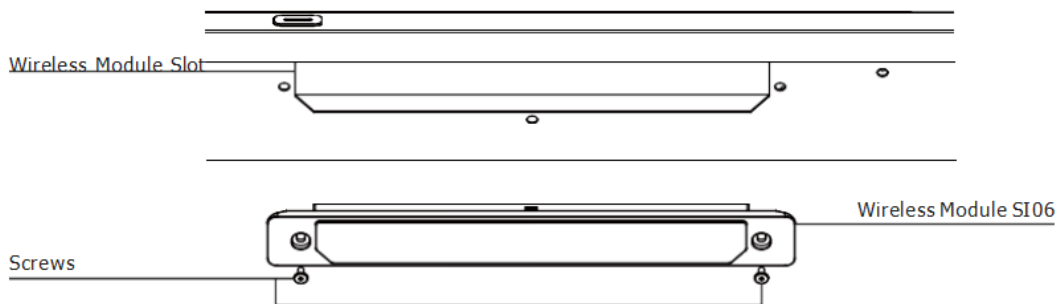

Installing the OPS/Android Module

Note: Please make sure the power is off before proceeding with the installation.

Step 1: Unscrew and remove the cover.

Step 2: Prepare the OPS/Android Module.

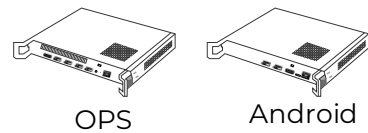
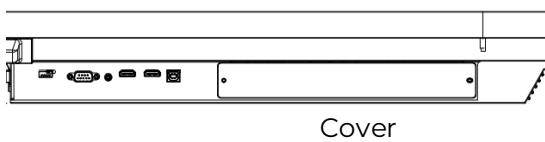

Step 3: Correct positioning of the modules and slots.

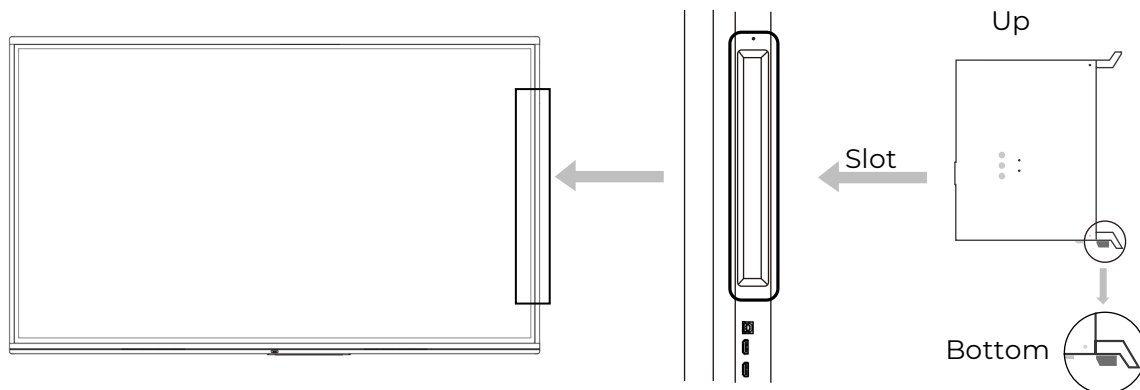

Step 4: Installation of OPS/Android module.

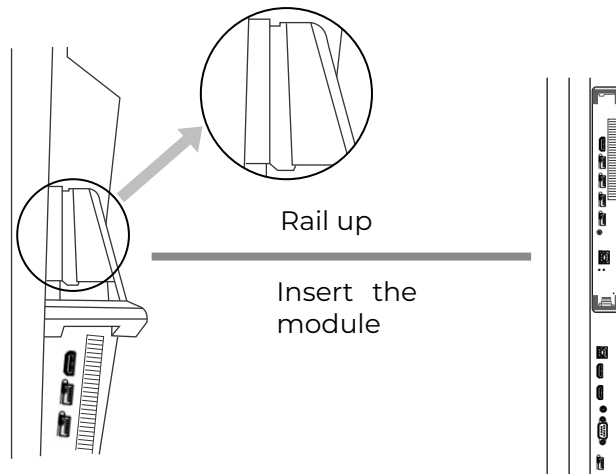

Removing the OPS/Android Module

Note: Please make sure the power is off before proceeding with the removal.

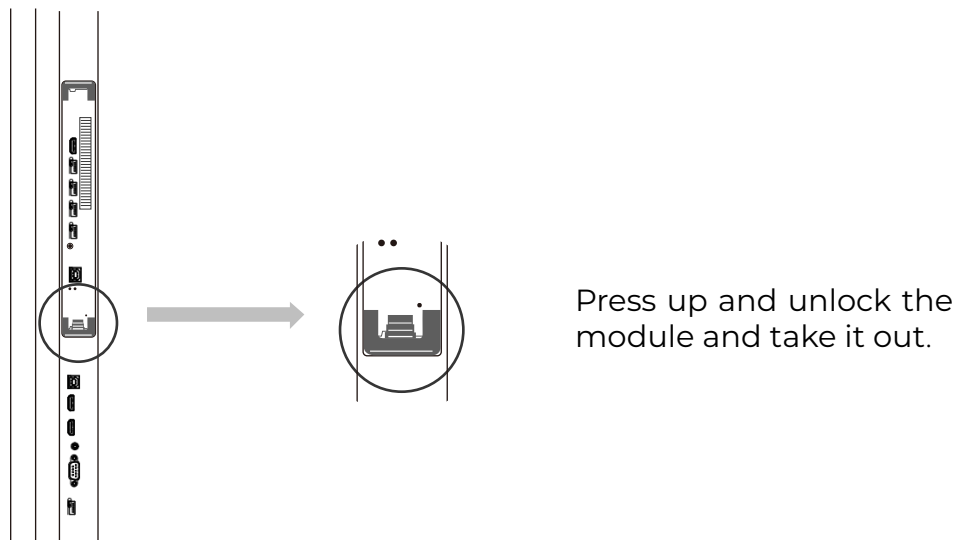

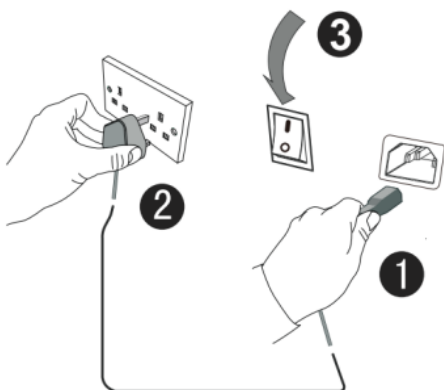

Turn the MAXHUB Interactive Flat Panel on and off

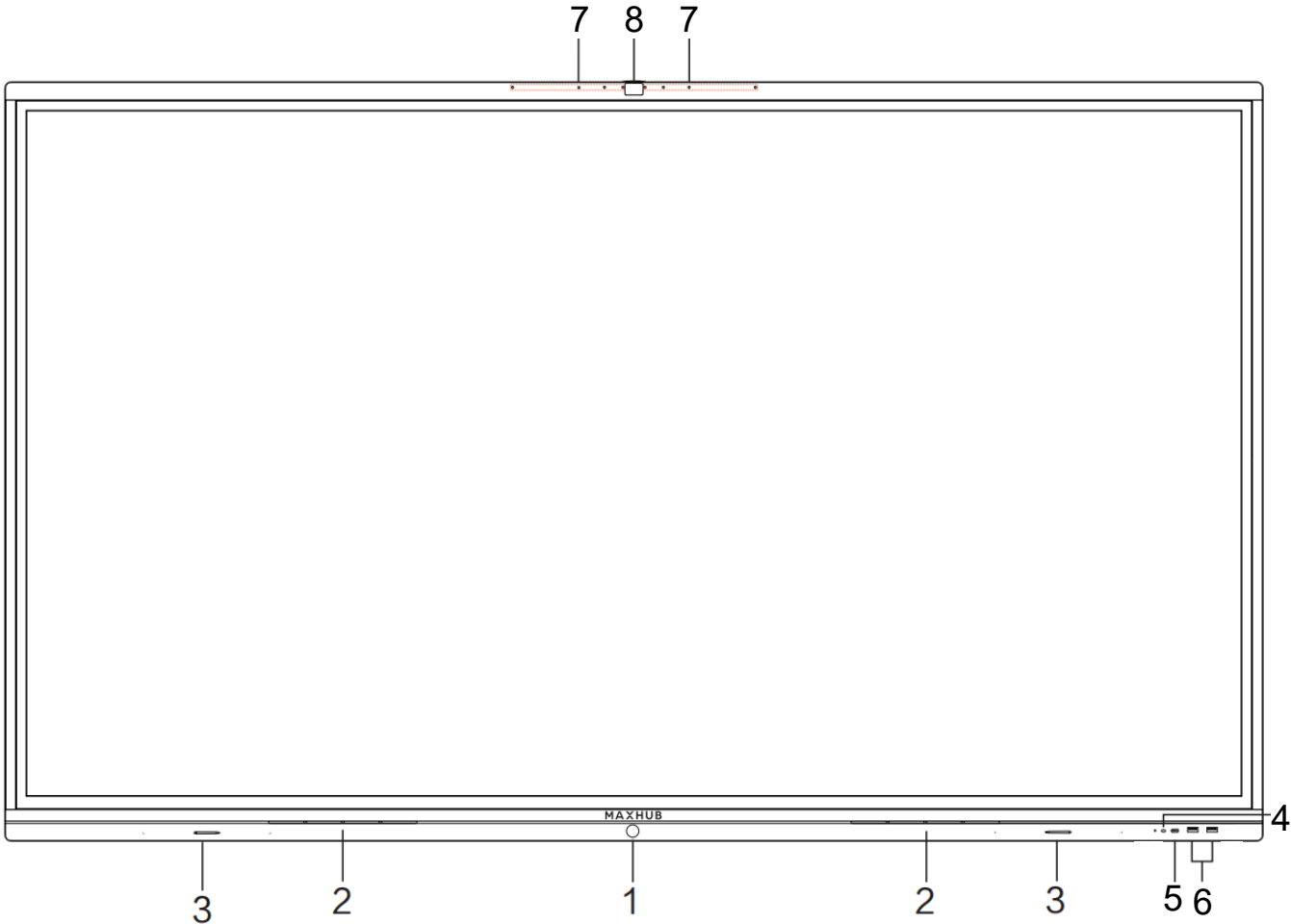

1. Plug the power cable into the power socket of the product.
2. Plug the power cable to the power supply.
3. Flip the rocker switch and press on power button to boot the product. The indicator will turn blue.

Product Appearance Introduction



Number	Description	Number	Description
1	 Press briefly to start the display or to switch from On to Standby Mode. Press and hold for 3 seconds to shut down the product.	5	USB Type-C
2	Speaker	6	USB 3.0
3	Stylus Magnet Area	7	Microphone
4	Infrared Receiver	8	48MP Camera

Note: USB Type-C does not support HDMI OUT function

Back Interface *Integrated in Interactive Flat Panel device

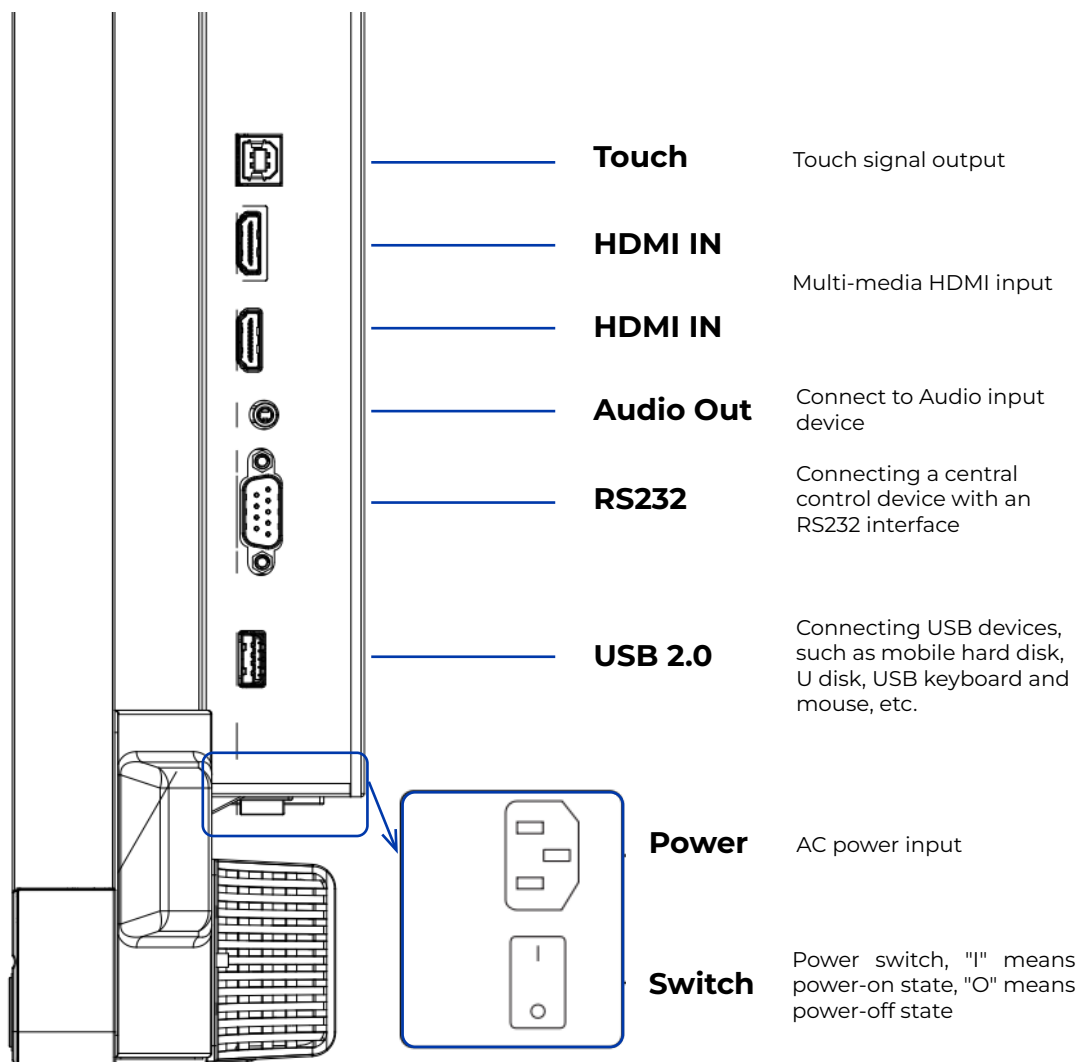

Interface function

1. HDMI signal input

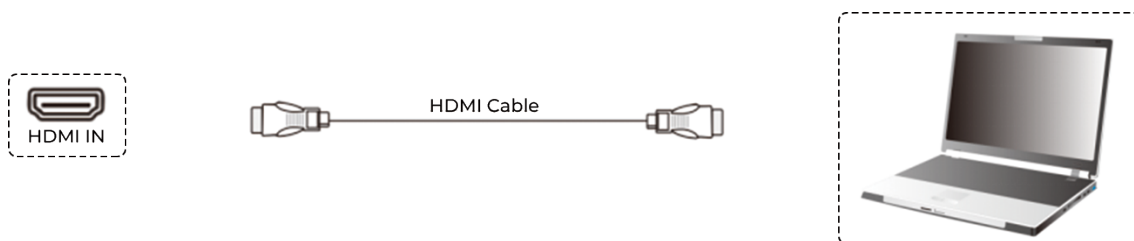

2. External computer and touch connection

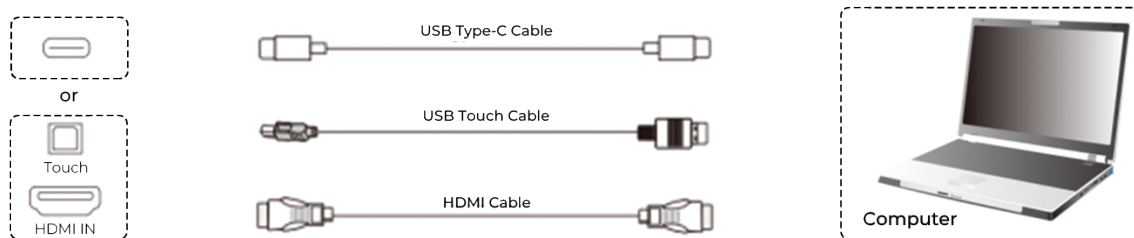

3. Audio signal output



4. RS232 device connection

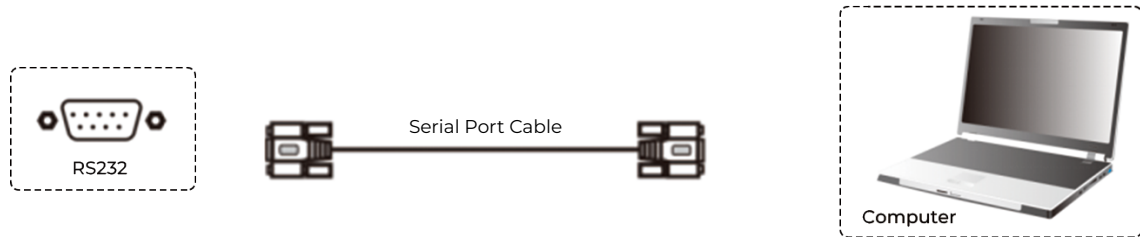

5. USB device connection

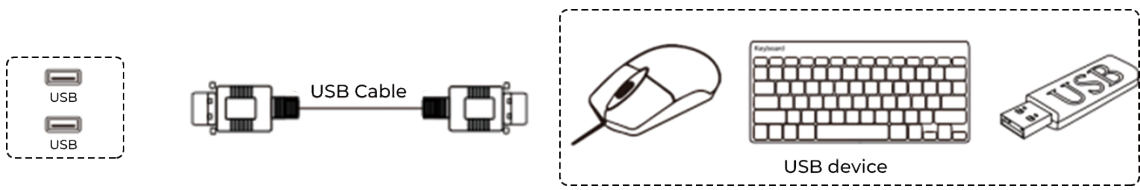

First Start of MAXHUB Interactive Flat Panel

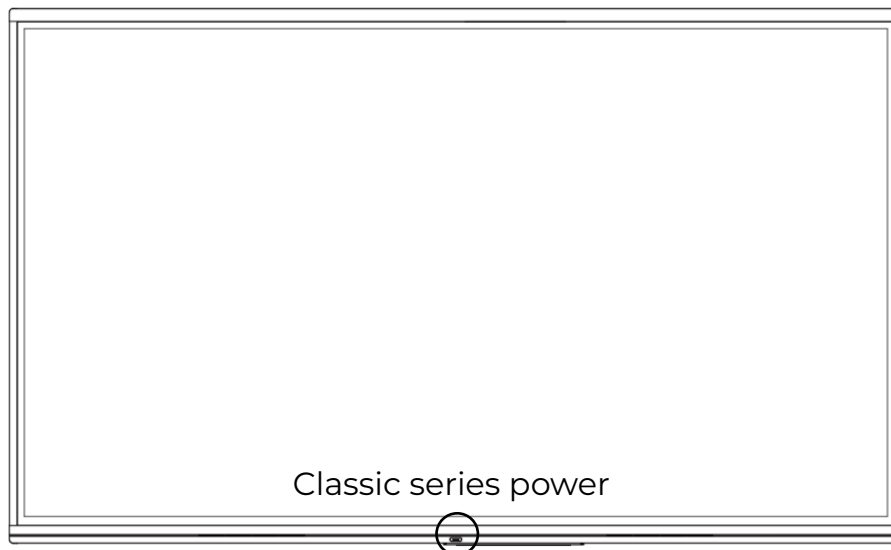

Press the power key to start the MAXHUB V6. Device is ready to be used with all the features.

Maintenance

Protecting the product from dust and moisture will help to prevent unexpected failures. Please clean the product regularly with a soft, dustless, dry cloth. Make sure to unplug the product before cleaning.

Cleaning the Screen

1. Dissolve the fabric softener or detergent in 75% alcohol.
2. Soak a piece of soft cloth in the solution.
3. Squeeze the cloth dry before use.
4. Do NOT allow the cleaning solution to drip onto other components of the product.

Cleaning the Touch Frame

1. Use dry, soft and dust-free wipes to clean the touch frame.
2. Unplug power.
3. During the stormy season or when you are not going to use the device for extended periods, please unplug the power.

Warranty

MAXHUB warrants its products to be free from defects in material and workmanship during the warranty period. If a product proves to be defective in material or workmanship during the warranty period, MAXHUB will, at its sole option, repair or replace the product with a similar product. Replacement Product or parts may include re-manufactured or refurbished parts or components. The replacement unit will be covered by the balance of the time remaining on the customer's original limited warranty. MAXHUB provides no warranty for any third-party software whether included with the product or installed by the customer, installation of any unauthorized hardware parts or components.

warranty coverage for MAXHUB products starts from the date of purchase. In order to receive warranty service, proof of purchase of the MAXHUB product is required. To obtain warranty service, please contact the MAXHUB service team.



MAXHUB Service Portal

Please Scan the QR Code to Contact Us
OR log in at this address:
<https://www.maxhub.com/en/service-portal>



NOTICE: The terms HDMI and HDMI High-Definition Multimedia Interface, and the HDMI Logo are trademarks or registered trademarks of HDMI Licensing LLC in the United States and other countries.

MAXHUB

Beyond Collaboration



www.maxhub.com/en/



sales@maxhub.com



<https://www.youtube.com/c/MAXHUB>



<https://www.facebook.com/MAXHUB.Global>



<https://www.linkedin.com/company/maxhub-overseas/>